

ABACUS FAMILY LED



The quality of life ...

APPLICATION

SURFACE WALL | BOLLARD



ABACUS 1



ABACUS 2



ABACUS 3



ABACUS 4



ABACUS 5

EN | FR | FI

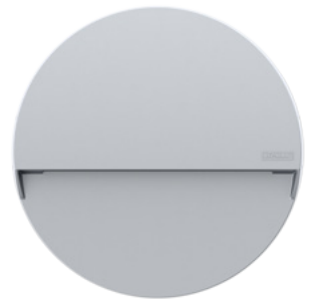

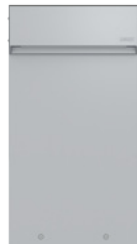

ABACUS FAMILY

Abacus Wall luminaires



IP65 · CLASS I · CE

A modern LED surface wall luminaire with smart design and easy for installation. Offer a medium rectangular and large size with square and circular shape that can be integrated in any surface wall context. The position of the LED offers a soft and comfortable asymmetrical visual light distribution with superior performances. Particularly suitable for any surface wall.

The luminaire rated as CLASS I with integral driver. Colour temperature 3000K and 4000K, LED CRI >80 and life time 50,000 Hours.

Die-cast aluminum frame and body with high corrosion resistance. Stainless steel fasteners in grade 316. Durable silicone rubber gasket and frosted glass diffuser. The housing is powder coating with high corrosion resistance and chemical chromatized protection.

Une applique murale au design épuré, facile à mettre en œuvre, disponible en version medium rectangulaire ou version large de forme carré ou ronde, qui pourra être préconisée sur toutes les utilisations murales. La position de la LED offre une distribution lumineuse asymétrique douce et confortable avec des flux élevés, particulièrement adaptée pour tous les murs.

Luminaire Classe I, driver inclus. Température LED 3000K ou 4000K, CRI>80 et durée de vie 50 000 heures.

Le corps est en aluminium résistant à la corrosion à faible teneur en cuivre. Accessoires externes en acier inoxydable de degré 316. Joint silicone et diffuseur en verre dépoli. Le luminaire est traité avec une protection chromatique chimique avant revêtement en poudre, assurant une résistance élevée à la corrosion.

Valikoima pyöreitä sekä neliskanttisia seinäpintaan asennettavia ilkivallan kestäviä valaisimia.

Valaisimien suojausluokka on I ja se toimitetaan sisäisellä LED driverilla varustettuna. Väriämpötilat 3000K ja 4000K, LED CRI >80. elinikä> 50000h L80/B10, MacAdam 3 SDCM

Runko on painevalettua korroosion kestäväää alumiinia. Ruuvit on ruostumatonta haponkestävää terästä AISI 316. Valaisimissa on silikon tiivisteeet sekä himmeä lasikehys. Polyesteri pulveripolttoaalattu runko



Ordering guide sample Échantillon de Guide de commande Valaisimen yksilöinti

AB-30001 - W30



Colour Temperature
 W30 – Warm white 3000K
 W40 – Neutral white 4000K

Series	Model No.	Lamp	Power	Lumen	EEC	Colour	Weight
MEDIUM							
ABACUS 1	AB-30001	30 LED	11 W	783 lm	A++	W30 / W40	1.3 kg.
LARGE							
ABACUS 2	AB-30011	30 LED	11 W	783 lm	A++	W30 / W40	1.7 kg.
ABACUS 3	AB-30021	30 LED	11 W	783 lm	A++	W30 / W40	1.7 kg.



Abacus 1



Abacus 2



ABACUS 1



ABACUS 2

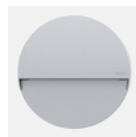

ABACUS 3

ABACUS 1

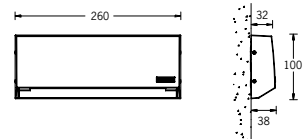

ABACUS 2

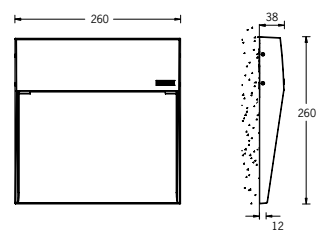

ABACUS 3

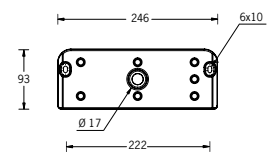
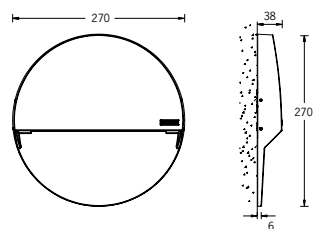

Mounting detail
 Instructions de montage
 Asennusohje

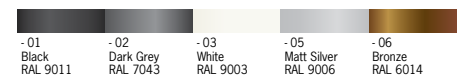
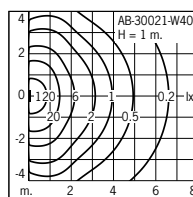
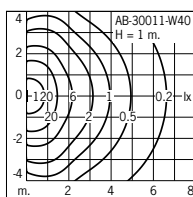
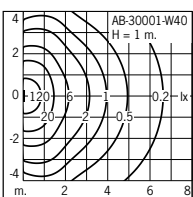

Abacus Bollards



IP65 · CLASS I · CE



A range of modern LED bollards. Offer two heights as well as rectangular and square on top of the extrusion column. The position of the LED offers a soft and comfortable asymmetrical visual light distribution with superior performances. Particularly suitable for any pedestrian areas, walk ways and entrances.

The luminaire rated as CLASS I with integral driver. Colour temperature 3000K and 4000K, LED CRI >80 and life time 50,000 Hours.

Extruded aluminium column, die-cast aluminum frame and body with high corrosion resistance. Stainless steel fasteners in grade 316. Durable silicone rubber gasket and frosted glass diffuser. The housing is powder coating with high corrosion resistance and chemical chromated protection.

Borne LED décorative très moderne disponible en deux tailles de forme rectangulaire et carrée au-dessus de la colonne d'extrusion. La borne Abacus offre une distribution lumineuse asymétrique douce et confortable avec des flux élevés idéale pour la mise en lumière de passerelles piétonnes, passages et entrées.

Luminaire de Classe I avec driver intégré. Températures de couleur 3000K et 4000K. Durée de vie des LED 50000 heures et IRC >80

Fût en aluminium extrudé et moulé sous pression en aluminium, laquée époxy avec protection chromatique offrant une haute résistance à la corrosion. Vis en acier inoxydable. Joint d'étanchéité en silicone élastomère et diffuseur en verre dépoli renforcé.

Nelikulmainen vankkarakenteinen pollarimissä valonlähde on sijoitettu pollarin yläosaan siten että saadaan aikaan erinomainen valonjako. Abacus sarjaan kuuluu myös seinään asennettavat valaisimet.

Valaisimien suojausluokka on I ja se toimittaan sisäisellä LED driverilla. Väriämpötilat 3000K ja 4000K, LED CRI >80, elinikä > 50000h L80/B10, MacAdam 3 SDCM

Runko on korroosion kestävää alumiinia. Ruuvit on ruostumatonta haponkestävää terästä AISI 316. Valaisimissa on silikonitiivisteet sekä karkaistu suojalasi. Polyesteri pulveripolttoaalattu runko.





Colour Temperature
 W30 – Warm white 3000K
 W40 – Neutral white 4000K

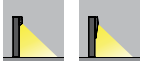

Series	Model No.	Lamp	Power	Lumen	EEC	Colour	Height	Weight	Accessory No.
ONE SIDE									
ABACUS 4	AB-10001	30 LED	11 W	783 lm	A++	W30 / W40	500	5.56 kg.	A12091
	AB-10011	30 LED	11 W	783 lm	A++	W30 / W40	1000	9.09 kg.	A12091
ABACUS 5	AB-10041	30 LED	11 W	783 lm	A++	W30 / W40	500	6.02 kg.	A12091
	AB-10051	30 LED	11 W	783 lm	A++	W30 / W40	1000	9.55 kg.	A12091
TWO SIDE									
ABACUS 4	AB-10021	2x30 LED	22 W	1566 lm	A++	W30 / W40	500	6.70 kg.	A12091
	AB-10031	2x30 LED	22 W	1566 lm	A++	W30 / W40	1000	10.22 kg.	A12091
ABACUS 5	AB-10061	2x30 LED	22 W	1566 lm	A++	W30 / W40	500	7.62 kg.	A12091
	AB-10071	2x30 LED	22 W	1566 lm	A++	W30 / W40	1000	11.15 kg.	A12091



ABACUS 4

ABACUS 5

ACCESSORY



A12091
Anchor bolt kit

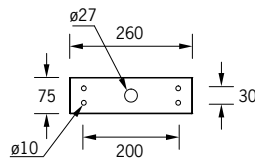

Mounting detail
Instructions de montage
Asennusohje

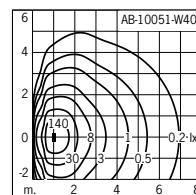
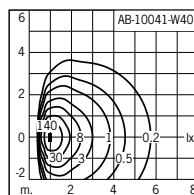
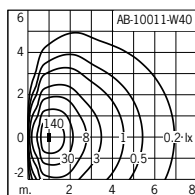
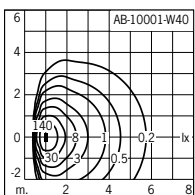
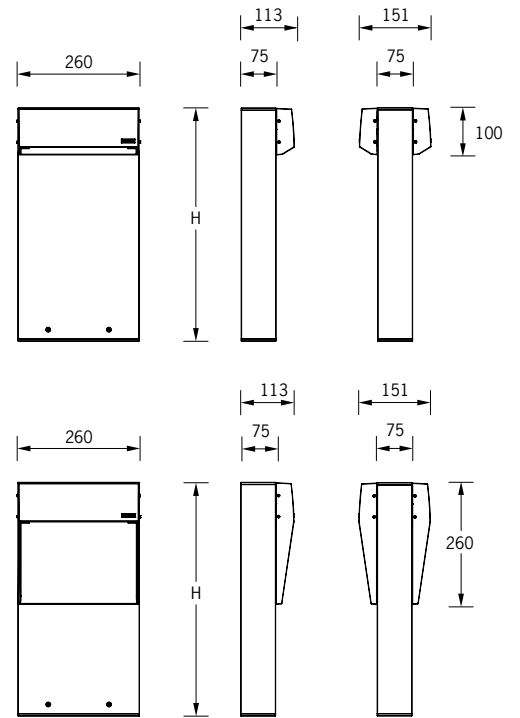



www.ligman.com/product/abacus

Efficient Lighting Systems has distributors
in each capital city in Australia and New Zealand.
To find your local distributor visit
www.elslighting.com.au



EFFICIENT LIGHTING SYSTEMS
39 TINNING ST BRUNSWICK VIC 3056
PO BOX 5084 MORELAND WEST VIC 3055
PHONE: 03 9222 5522
FAX: 03 9222 5521
EMAIL: info@elslighting.com.au
www.elslighting.com.au