

ROYALE WALL LIGHT

DIFFUSED LED WALL LIGHT



- Suitable for wall mounting – horizontal or vertical
- 3000K or 4000K
- High output satin opal acrylic lens specifically designed for use with LED
- Curved end lens or straight end lens
- Chrome lens retainers
- IPX4 version available
- Made in Australia

RY400 LED

Electronic Non Dimmable & Trailing Edge Dimmable		CCT	Lumens	Watts
Curved End Lens	Straight End Lens			
RYC400.13.3000.61.SOA	RYS400.13.3000.61.SOA	3000K	946	13
RYC400.13.4000.61.SOA	RYS400.13.4000.61.SOA	4000K	1100	13

RY500 LED

Electronic Non Dimmable & Trailing Edge Dimmable		CCT	Lumens	Watts
Curved End Lens	Straight End Lens			
RYC500.25.3000.61.SOA	RYS500.25.3000.61.SOA	3000K	1788	25
RYC500.25.4000.61.SOA	RYS500.25.4000.61.SOA	4000K	1950	25

DIMENSIONS

Royale 400 – curved end lens

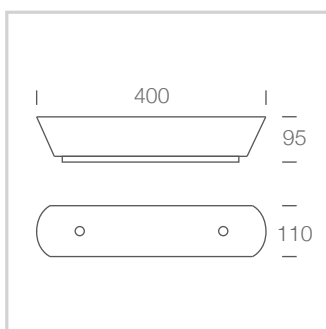

Royale 400 – straight end lens

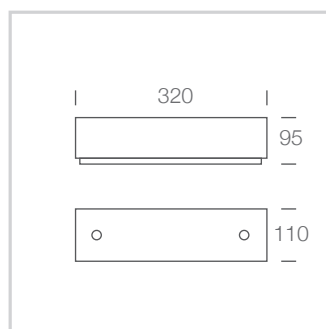

Royale 500 – curved end lens

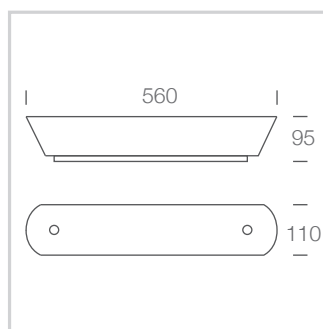

Royale 500 – straight end lens

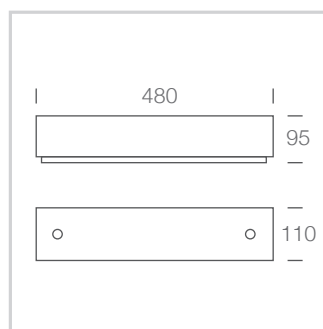

Street Address:
39 Tinning Street, Brunswick,
Victoria, 3056, Australia

Postal Address:
PO BOX 5084
Moreland West VIC 3055

T +61 3 9222 5522
www.elslighting.com.au

